

ICOM

INSTRUCTION MANUAL

UHF C.R.S. TRANSCEIVER

**IC-40GX**

Icom Inc.

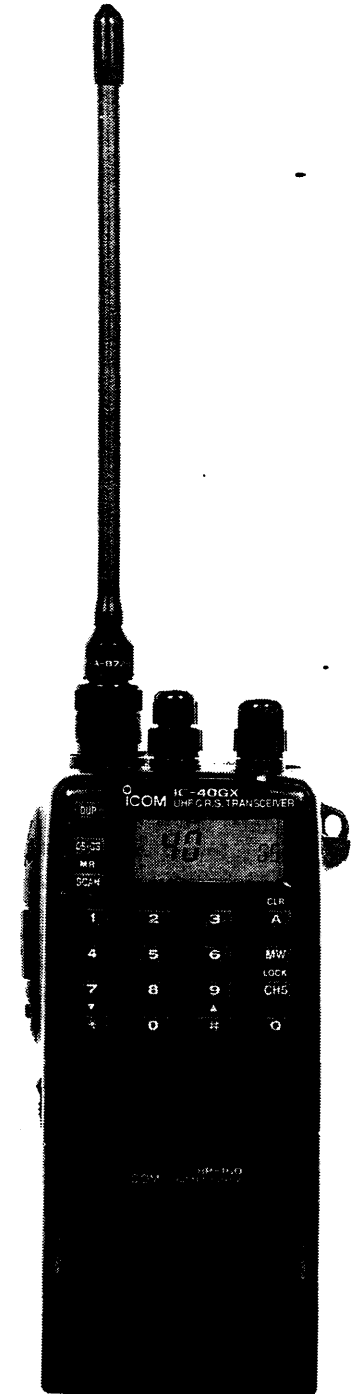

---

## IMPORTANT

---

**READ ALL INSTRUCTIONS** carefully and completely before using the transceiver.

**SAVE THIS INSTRUCTION MANUAL** – This instruction manual contains important safety and operating instructions for the IC-40GX.

When no ID codes and other contents have been programmed, the 5-tone function and quiet function cannot be used. In this case, the [MONI] and [Q] switches do not function. Ask your dealer for ID code.

---

## EXPLICIT DEFINITIONS

---

WORD	DEFINITION
CAUTION	Equipment damage may occur.
NOTE	If disregarded, inconvenience only. No risk of personal injury, fire or electric shock.

---

## CAUTIONS

---

**NEVER** connect the transceiver to an AC outlet or to a power source of more than 16 V DC.

**NEVER** connect the transceiver to a power source using reverse polarity. This connection will ruin the transceiver.

**NEVER** allow children to touch the transceiver.

**AVOID** using or placing the transceiver in direct sunlight or in areas with temperatures below  $-10^{\circ}\text{C}$  ( $+14^{\circ}\text{F}$ ) or above  $+60^{\circ}\text{C}$  ( $+140^{\circ}\text{F}$ ).

**BE CAREFUL!** When transmitting for a long time with high output power, the rear panel will become hot.

**BE CAREFUL!** During external DC power operation, the connected battery pack or battery case is charged. If the BP-130A BATTERY CASE is connected, remove dry cell batteries. Otherwise, battery leakage may occur.

**BE CAREFUL!** The use of non-Icom battery packs and chargers may impair transceiver performance and invalidate the warranty.

# TABLE OF CONTENTS

IMPORTANT .....	i
EXPLICIT DEFINITIONS .....	i
CAUTIONS .....	i
TABLE OF CONTENTS .....	ii
UNPACKING .....	ii

<b>1 PANEL DESCRIPTION</b> .....	<b>1-4</b>
■ Front and side panels .....	1
■ Top panel .....	2
■ Keyboard .....	3
■ Function display .....	4
<b>2 PRE-OPERATION</b> .....	<b>5-8</b>
■ Battery pack charging .....	5
■ Battery pack precautions .....	5
■ About the battery pack .....	5
■ Charging connections .....	6
■ Dry cell battery installation .....	7
■ Accessory attachment .....	8
<b>3 BASIC OPERATION</b> .....	<b>9-12</b>
■ Receiving .....	9
■ Selecting a channel .....	9
■ Selecting channel 5 .....	10
■ Lock function .....	10
■ Display lighting .....	11
■ Transmitting .....	11
■ Output power selection .....	12
■ Repeater operation .....	12

<b>4 5-TONE OPERATION</b> .....	<b>13-15</b>
■ General .....	13
■ Calling a specific station .....	13
■ Waiting for a call .....	14
■ Calling bell on/off .....	14
■ 5-tone code memory .....	15
■ Quiet function .....	15
<b>5 SCAN OPERATION</b> .....	<b>16-18</b>
■ Scan types .....	16
■ Open scan .....	16
■ Group scan .....	17
■ Setting scan channels .....	18
■ Scan resume condition .....	18
<b>6 OTHER FUNCTIONS</b> .....	<b>19</b>
■ Power saver .....	19
■ Beep tone on/off .....	19
■ Time-out timer .....	19
<b>7 MODE ARRANGEMENT CHART</b> ...	<b>20</b>
<b>8 TROUBLESHOOTING</b> .....	<b>21</b>
<b>9 SPECIFICATIONS</b> .....	<b>22</b>
<b>10 OPTIONS</b> .....	<b>23-24</b>

# UNPACKING

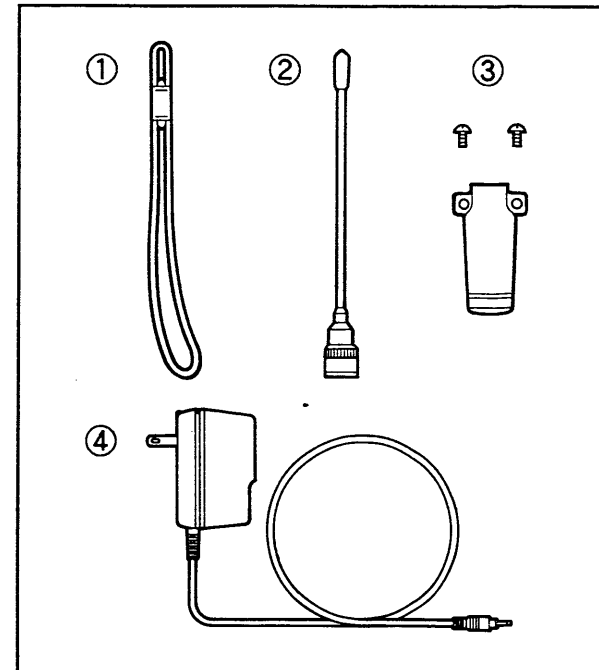

Included accessories:	Qty.
① Handstrap .....	1
② Antenna (FA-B72U) .....	1
③ Belt clip and screws .....	1 set
④ Wall charger .....	1

Battery pack (BP-160)  
(attached to the transceiver) ..... 1

# 1

## PANEL DESCRIPTION

### ■ Front and side panels

#### 5-TONE SWITCH [MONI] (p. 13)

- Selects 5-tone mode.
- Selects 5-tone memory mode when pushed and held for 2 sec.
- Transmits the displayed 5-tone code when pushed and held for 2 sec.

#### FUNCTION SWITCH [F] (p. 3)

While pushing this switch, [CH5•LOCK] locks the main dial, keyboard, etc.

- "Push [F] + [CH5•LOCK]" means "while pushing the [F] switch, push [CH5•LOCK]."

#### PTT SWITCH [PTT] (p. 11)

Push and hold to transmit; release to receive.

#### LIGHT SWITCH [LIGHT] (p. 11)

Turns the display lighting ON and OFF.

- This switch has a 5 sec. timer and the timer can be turned OFF for continuous lighting using set mode.

#### DUPLEX SWITCH [DUP] (p. 12)

Sets the duplex condition for repeater use on channels 1–8.

#### OPEN SCAN/GROUP SCAN SWITCH [OS/GS] (p. 16)

Selects open or group scan.

#### FUNCTION DISPLAY (p. 4)

#### SCAN SWITCH [SCAN•MR] (p. 16)

- Starts open or group scan.
- Sets the displayed channel as a scan channel when pushed and held for 2 sec.

#### KEYBOARD (p. 3)

#### SPEAKER AND MICROPHONE

#### BATTERY PACK RELEASE BUTTON

Opens the latch for battery pack removal when pushed upwards. (p. 7)

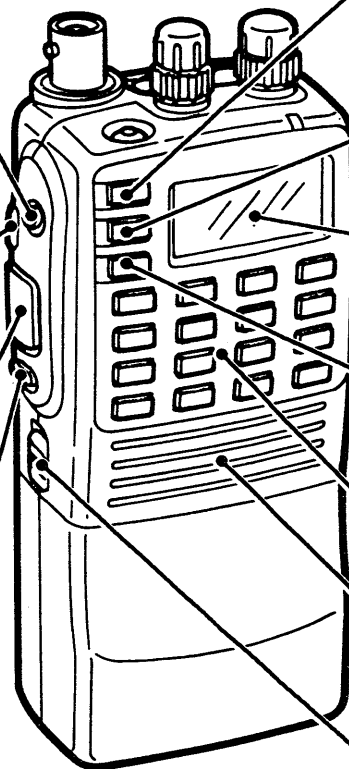

## ■ Top panel

### EXTERNAL DC POWER JACK

[DC12.5V] (p. 23)

Allows operation with a 12.5 V DC power source using the optional cables, CP-13/L or OPC-288/L.

**CAUTION:** Operation with an external DC power source simultaneously charges batteries inside the battery case or the battery pack. This may cause battery leakage and damage the transceiver or cause battery overcharging and shorten the life of the battery pack, respectively.

**ANTENNA CONNECTOR** (p. 8)

Connects the supplied antenna.

### HIGH/LOW SWITCH [H/L•SET]

- Selects high or low output power. (p. 12)
- Enters set mode when pushed and held for 2 sec. (p. 20)

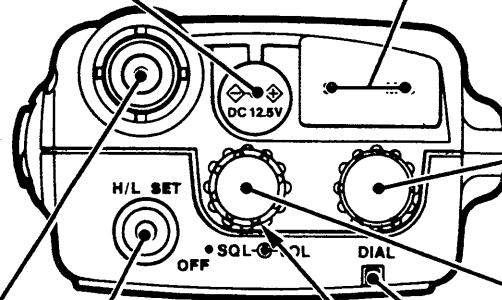

### EXTERNAL SPEAKER AND MICROPHONE JACKS [SP]/[MIC]

Connect an optional speaker-microphone or headset, if desired. The internal speaker will not function when either is connected. The HM-9 cannot be used. (p. 24)

### MAIN DIAL [DIAL]

Selects operating channel, 5-tone digit and set mode contents.

**VOLUME CONTROL [VOL]** (p. 9)

Adjusts the audio level.

**TX/RX INDICATOR** (pgs. 9, 11)

**SQUELCH CONTROL [SQL]** (p. 9)

Varies the squelch threshold point for noise mute.

# 1 PANEL DESCRIPTION

## Keyboard

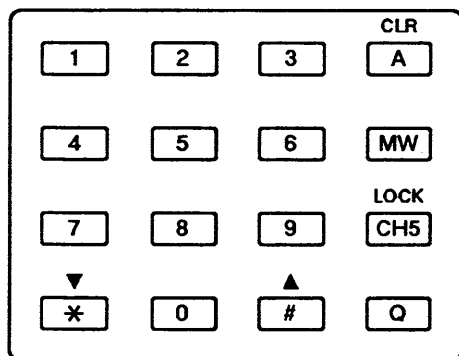

KEY	FUNCTION
<p>1</p> <p>to</p> <p>0</p>	<ul style="list-style-type: none"> <li>- Selects the desired memory channel. (p. 9)</li> <li>- Inputs 4th and 5th digits of 5-tone code in 5-tone mode. (p. 15)</li> <li>- Selects the desired code memory in 5-tone memory mode. (p. 15)</li> </ul>
<p>▲</p> <p>#</p> <p>▼</p> <p>*</p>	<ul style="list-style-type: none"> <li>- Changes the memory channel when pushed. (p. 9)</li> <li>- Changes the memory channel continuously when pushed and held. (p. 9)</li> <li>- Selects the set mode display in set mode. (p. 20)</li> <li>- Selects 4th or 5th digit of 5-tone code in 5-tone mode. (p. 15)</li> </ul>
<p>CLR</p> <p>A</p>	<ul style="list-style-type: none"> <li>- Clears the input digit and retrieves the memory channel. (p. 9)</li> <li>- Inputs "A" (group code) to the 4th or 5th digit of the 5-tone code in 5-tone mode. (p. 15)</li> <li>- Exits set mode or 5-tone memory mode. (p. 20)</li> <li>- Exits 5-tone mode when pushed and held. (p. 20)</li> </ul>
<p>MW</p>	<ul style="list-style-type: none"> <li>Sets the displayed 5-tone code for programming when pushed and held in 5-tone mode. (p. 15)</li> </ul>
<p>LOCK</p> <p>CH5</p>	<ul style="list-style-type: none"> <li>- Select channel 5 in this sequence: channel 5 duplex → channel 5 simplex → previous memory channel. (p. 10)</li> <li>- Turns the lock function ON and OFF while pushing [F]. (p. 10)</li> </ul>
<p>Q</p>	<ul style="list-style-type: none"> <li>- Sets the displayed channel as a quiet channel when pushed and held. (p. 15)</li> <li>- Turns the quiet function ON and OFF. (p. 15)</li> </ul>

## Function display

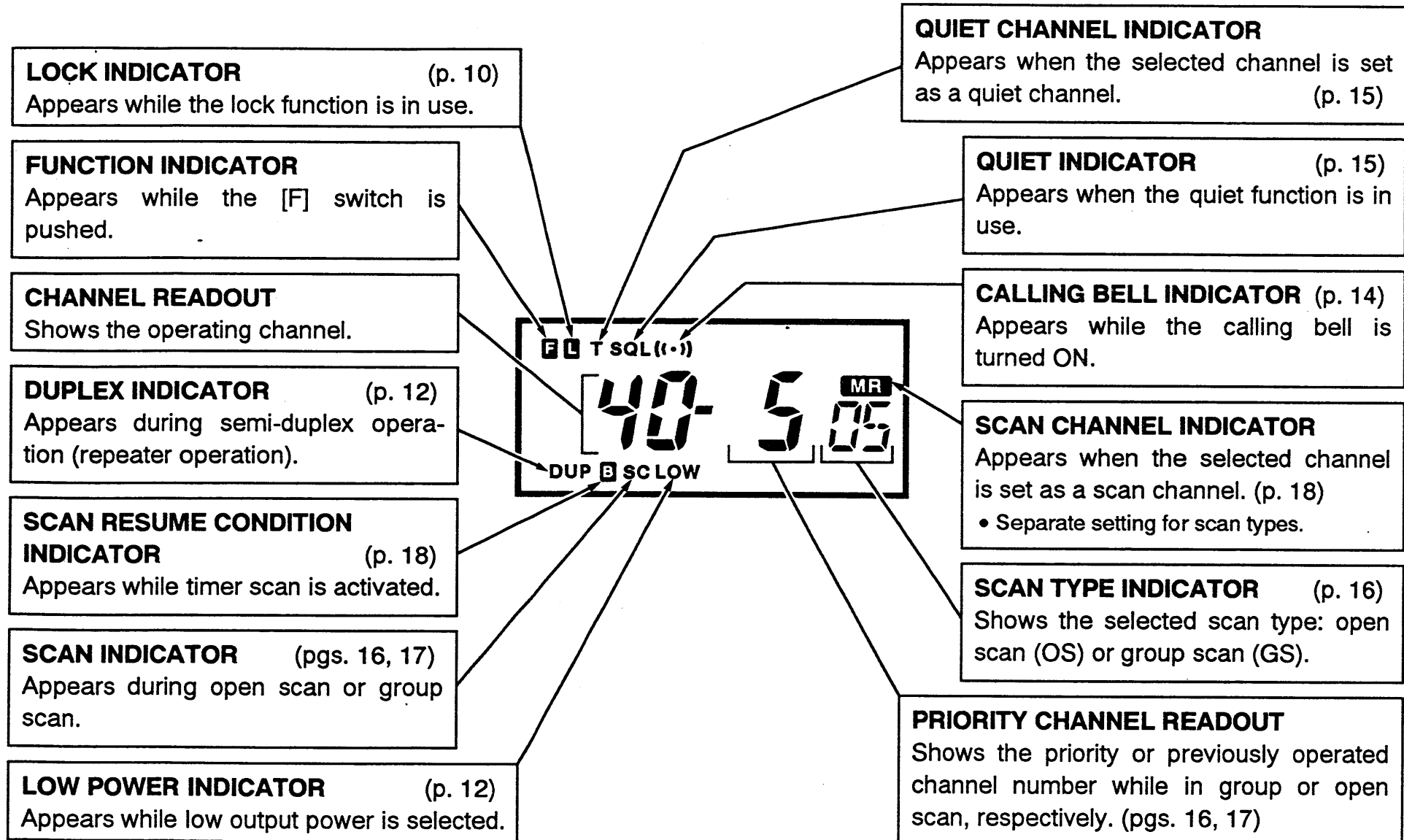

## ■ Battery pack charging

Charge the battery pack before first operating the transceiver and when the battery pack becomes exhausted.

## ■ Battery pack precautions

**NEVER** attempt to charge dry cell batteries inside the BP-130A BATTERY CASE. This will cause internal liquid leakage and damage the battery case or transceiver.

**NEVER** throw a battery pack into a fire.

**NEVER** expose the battery pack to water.

**NEVER** short the metal terminals of a battery pack.

**DO NOT** attempt to charge a fully charged battery pack.

**DO NOT** discharge a battery pack completely.

**AVOID** overcharging. Disconnect the wall charger within 48 hrs.

Charging may not occur in extreme cold (under 0°C; +32°F) or extreme heat (over +40°C; +104°F).

## ■ About the battery pack

### ◇ Using your battery pack wisely

Recharging can usually be performed 300 times, but battery life can be lengthened to about 500 recharges as follows:

- Use the battery pack until it becomes almost completely exhausted under normal conditions.
- Charge as soon as transmitting becomes impossible.

Full charge capacity may become lower when repeatedly recharging after only partial discharging. If this occurs, discharge almost completely through normal use before recharging.

### ◇ Operating periods

BATTERY PACK	VOLTAGE	CAPACITY	APPROX. OPERATING PERIOD*	
			COND. 1	COND. 2
BP-130A	Battery case R6 (AA) × 6		Varies according to installed batteries.	
BP-157A	7.2 V	900 mA	10 h 5 m	5 h 45 m
BP-160	7.2 V	700 mA	7 h 50 m	4 h 25 m
BP-174	12.0 V	600 mA	5 h 30 m	3 h

**Condition 1:** Tx (High): Rx: Standby (power saved) = 1:1:18 (min.)

**Condition 2:** Tx (High): Rx: Standby (power saved) = 1:1:8 (min.)

Operating periods are estimated values and vary depending on output power, temperature, etc.



## ■ Charging connections

### ◇ Regular charging with transceiver

Connect the supplied wall charger to the [DC12.5V] jack.

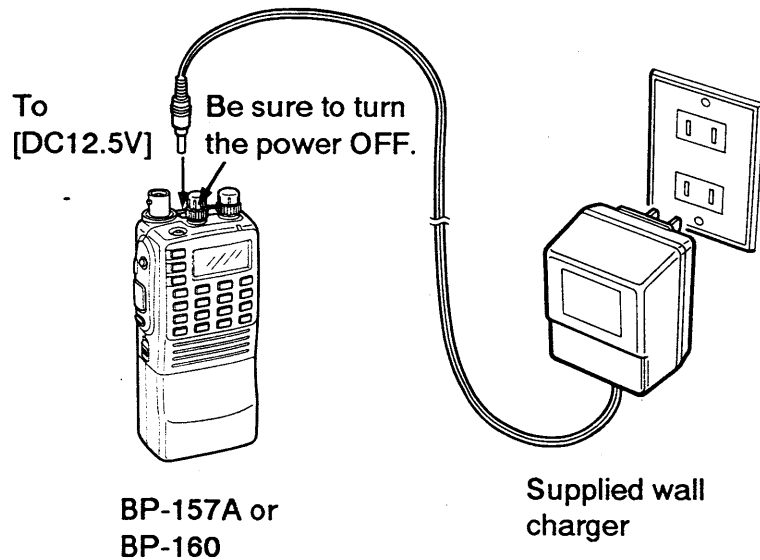

- Approx. charging period: 15 hrs.
- The optional BP-174 BATTERY PACK cannot be charged via the [DC12.5V] jack. For BP-174 charging, refer to "Rapid charging with the optional BC-79" at right, or p. 7 "Charging without transceiver."
- The optional CP-13/L CIGARETTE LIGHTER CABLE WITH NOISE FILTER or OPC-288/L DC POWER CABLE with a 12 to 16 V DC power source can also be used.

### ◇ Rapid charging with the optional BC-79

- ① Insert the optional AD-28 BATTERY PACK ADAPTER into the charging slot of the BC-79 DESKTOP CHARGER.
- ② Firmly insert a battery pack into the AD-28.

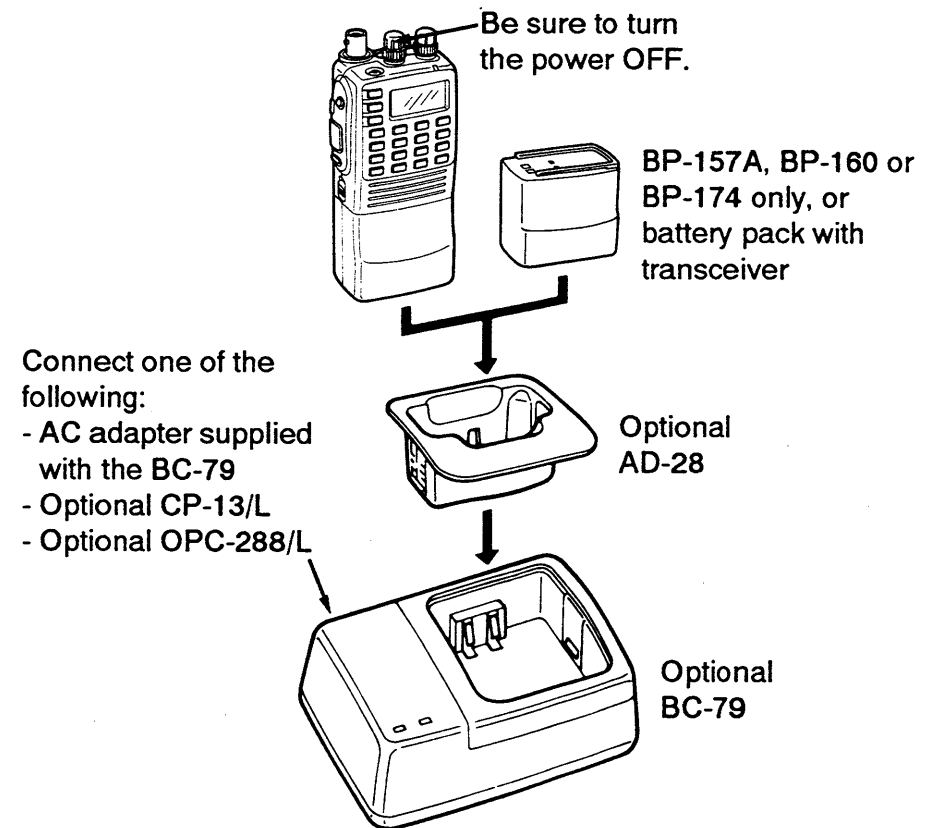

- Approx. charging period  
BP-157A, BP-160: 1 hr. BP-174: 1.5 hrs.

## 2 PRE-OPERATION

### ◇ Charging without transceiver

Attach an optional AD-25 BATTERY CHARGE ADAPTER to the battery pack. Connect one of the following:

- CP-13/L CIGARETTE LIGHTER CABLE WITH NOISE FILTER
- OPC-288/L DC POWER CABLE
- Supplied wall charger

Optional CP-13/L

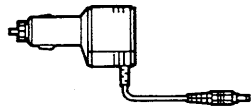

To 12 V cigarette lighter socket

Optional OPC-288/L

⊕ White



⊖ Black



To 12-16 V DC power source

Supplied wall charger

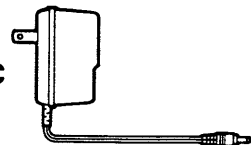

To AC outlet

Optional AD-25

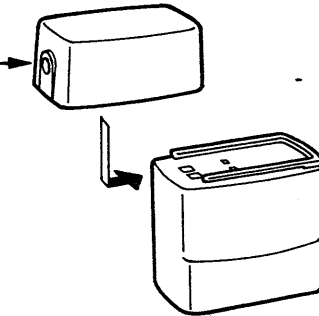

BP-157A, BP-160  
or BP-174

- Approx. charging period  
BP-157A, BP-160: 15 hrs.

BP-174: 20 hrs.

## ■ Dry cell battery installation

An optional BP-130A BATTERY CASE is available. Install six dry cell batteries as follows.

- ① Push and hold the battery release button upwards, then slide the battery case to the right with the transceiver facing you. (Fig. 1)
- ② Open the battery case. (Fig. 2)
- ③ Install 6 dry cell batteries. (Fig. 3)
  - Pay attention to the polarities.

Fig. 1

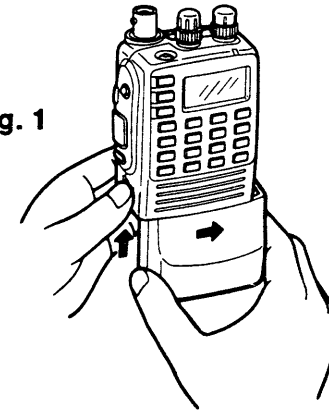

### BE CAREFUL!

Before external DC power operation, remove dry cell batteries to prevent battery leakage.

Fig. 2

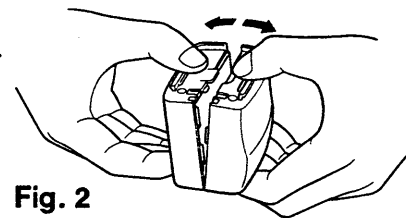
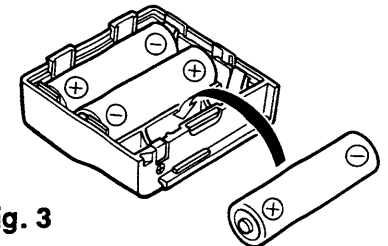

Fig. 3



## ■ Accessory attachment

### ◇ Antenna

Connect the supplied flexible antenna into the antenna connector and rotate clockwise.

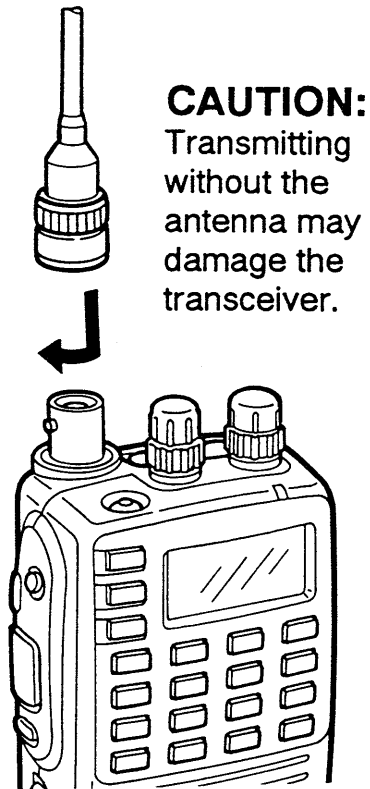

### ◇ Belt clip

Remove the plastic screws, then attach the belt clip with the supplied metal screws. Conveniently attaches to your belt.

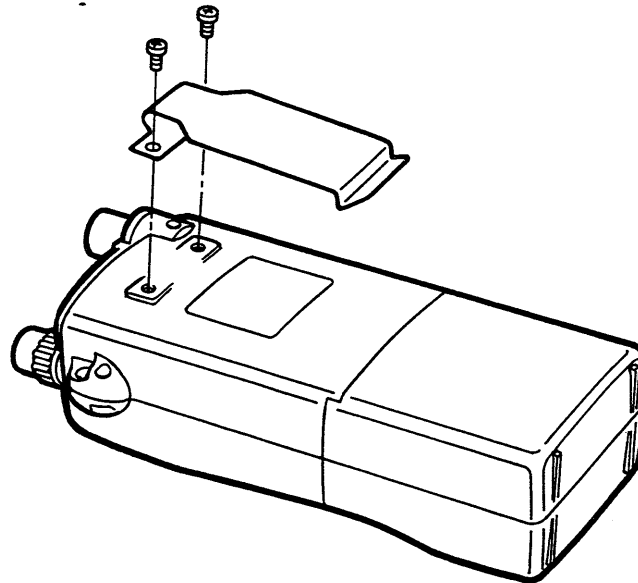

### ◇ Handstrap

Install the handstrap as shown in the figure below. Facilitates carrying.

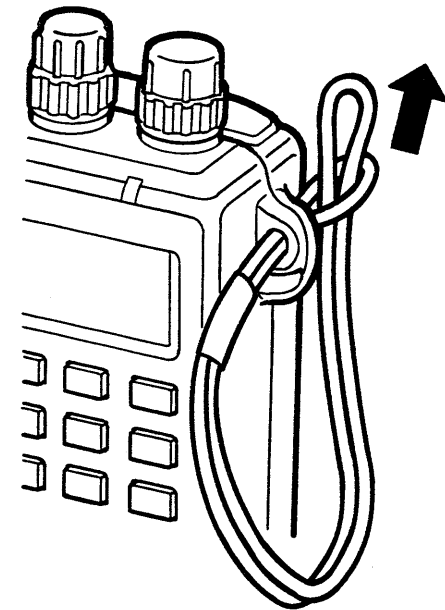

## Receiving

- ① Rotate [VOL] to turn power ON.
- ② Set the audio level.
  - Rotate [SQL] maximum counterclockwise.
    - If "T SQL" appears on the display, push [Q] to cancel the quiet function. (p. 15)
  - Rotate [VOL] to adjust the desired audio output level.
  - Rotate [SQL] clockwise until noise is muted.
- ③ Select the desired channel with the main dial, etc. (pgs. 9, 10)

### When a signal is received:

- The TX/RX indicator lights up in green.
- Squelch opens and audio is emitted from the speaker.

## Selecting a channel

When the lock function is in use ("L" appears.), channels cannot be selected. Push [F] + [CH5•LOCK] in advance.

### Using the main dial

Rotate the main dial to select the desired channel.

### Using the ▲ / ▼ keys

- Push [⊕•▲] or [⊗•▼] to select the desired channel.
- Push and hold [⊕•▲] or [⊗•▼] for rapid selection.

### Using the digit keys

Push the desired channel number (01–09, 10–40) using the corresponding digit keys.

- When a digit is mistakenly input, push [Ⓐ CLR] to clear the input, then start again.
- "0" – "4" are acceptable for the 1st digit.

**[EXAMPLE]:** Selecting channel 25.

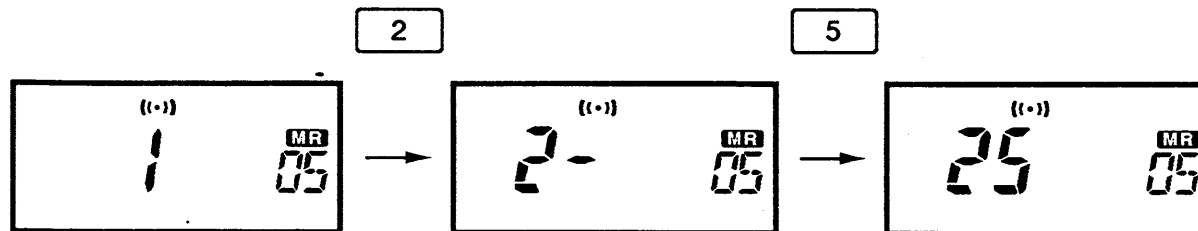

## ■ Selecting channel 5

The transceiver can quickly access channel 5 for emergency calls.

- ① Push [CH5] to select channel 5 with repeater settings; push [CH5] again to select channel 5 in simplex.
  - Cancel the lock function in advance.
- ② Push [CH5] once or twice to return to previously selected channel.
  - Selecting a channel from channel 5 via digit keys or via the main dial clears the previously selected channel.

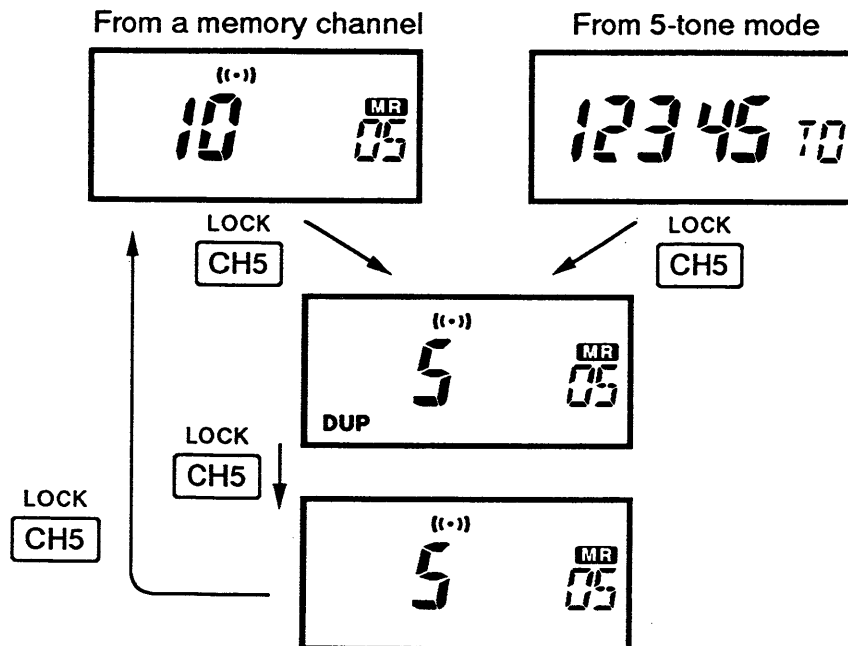

## ■ Lock function

The lock function prevents accidental channel changes and accidental function activation. [PTT] and [LIGHT] can be used while the lock function is in use.

/// The lock function cannot be used while in 5-tone or 5-tone memory modes.

- ① Push [F] + [CH5•LOCK] to turn the function ON.

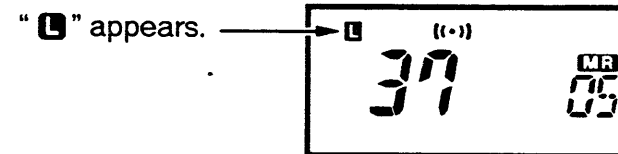

- ② To turn the function OFF, repeat step ① above.
  - "L" disappears.

## 3 BASIC OPERATION

### ■ Display lighting

The transceiver has display lighting with a 5 sec. timer for nighttime operation. The display lighting can be turned ON continuously, if desired.

Push [LIGHT] to turn the lighting ON or OFF.

- When the 5 sec. timer is set, the lighting will automatically turn OFF when switches or the main dial have not been operated for 5 sec.
- The lighting is turned OFF when the power is turned OFF and ON again.

#### USING SET MODE

##### SELECTING THE LIGHT SWITCH FUNCTION

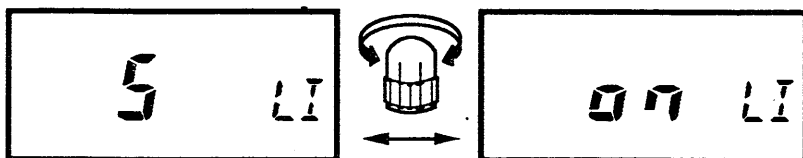

5 sec. timer is selected.

Continuous lighting is selected.

- ① Be sure a channel number is displayed.
- ② Push [H/L-SET] for 2 sec. to enter set mode.
- ③ Push [⊕•▲] or [⊗•▼] one or more times until "LI" (light) appears as shown above.
- ④ Rotate the main dial to select the 5 sec. timer or continuous lighting ("on").
- ⑤ Push [A•CLR] to exit set mode.

### ■ Transmitting

**CAUTION:** Transmitting without an antenna may damage the transceiver.

- ① Select the desired channel. (pgs. 9, 10)
- ② Push [H/L] to select output power, if desired. (p. 12)
  - "LOW" appears when selecting low output power and disappears when selecting high output power.
- ③ Push and hold [PTT] to transmit.
  - The TX/RX indicator lights up in red.
  - If "T SQL" appears on the display, transmitting is not possible. Push [Q] to cancel the quiet function. (p. 15)
- ④ Speak into the microphone at a normal voice level.
  - DO NOT hold the transceiver too close to your mouth or speak too loudly. This may distort the signal.
- ⑤ Release [PTT] to return to receive.

## ■ Output power selection

The transceiver has 2 output power levels to suit your operating requirements. Low output power during short-distance communication may reduce interference to other stations and conserves the battery power.

Push [H/L] to select high or low output power.

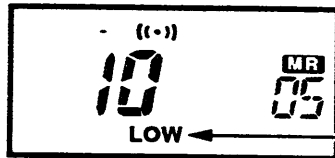

Appears while low output power is selected.

POWER SELECTION	OUTPUT POWER (typical)	
	with 13.5 V	with 7.2 V
HIGH	5.0 W	1.5 W
LOW	0.7 W	0.7 W

### ◇ If set mode is accidentally selected

**DO NOT** push and hold [H/L] continuously, since set mode may be selected. If set mode is accidentally selected, push [H/L] or [A]•CLR] to exit set mode.

## ■ Repeater operation

A repeater amplifies received signals and retransmits them on a different channel, allowing to communicate over greater distances with improved reliability. When using a repeater, the transmit channel is shifted from the receive channel by 30 channels.

- ① Select the receive channel from 1–8 (repeater output channel). (pgs. 9, 10)
- ② Push [DUP] to set duplex.
  - “DUP” appears.
  - The duplex setting effects the selected channel only and is automatically programmed into the selected channel.
- ③ Push and hold [PTT] to transmit.
  - The displayed channel automatically changes to the transmit channel (repeater input channel).
  - If “T SQL” appears on the display, push [Q] to cancel the quiet function. (p. 15)
- ④ Release [PTT] to receive.
- ⑤ To cancel the duplex setting, push [DUP] on the desired channel.

# 4

## 5-TONE OPERATION

### ■ General

**5-tone functions can be used with transceivers which have programmed ID codes, etc.**

The transceiver uses a CCIR 5-tone system for paging and can be used as a “message pager” to inform you of a caller’s identity even if you leave the transceiver temporarily unattended (a dealer must set the caller’s transceiver to transmit its ID code).

Personal calls and group calls are available with the 5-tone system. Personal calls use the receiving station’s ID code for calling. The receiving station’s display shows your ID code and the station knows that you called. The receiving station automatically transmits an answer back call and cancels the quiet function when used. You can also call all stations in your group using the group call.

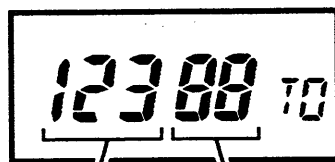

Dealer programmed digits

User programmable digits

### ■ Calling a specific station

- ① Select the desired channel.
- ② Push [MONI] to enter 5-tone mode.
- ③ Push 2 digit keys to set the desired station’s ID or group code.
  - “A” stands for a group code.
  - The main dial and [⊕•▲]/[⊗•▼] keys can also be used.
  - 10 5-tone code memory channels are available. (p. 15)

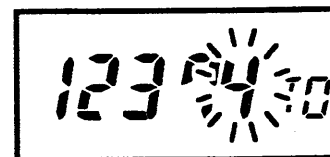

- ④ Push [MONI] for 2 sec. to transmit the displayed 5-tone code.
- ⑤ 2 beep tones are received from the station or group stations as an answer back call.
- ⑥ Operate the transceiver normally. (Push [PTT] to transmit; release to receive.)

#### What is an ID code?

ID codes identify individual transceivers. The first 3 digits of the ID code are your group ID code and cannot be changed. Therefore, 5-tone codes cannot be used to call between different groups.



## ■ Waiting for a call

No special setting is necessary because the transceiver checks signals whether they include ID codes or not.

- ① Select the desired channel.
- ② Turn the quiet function ON, if required.
  - Push [Q] for 2 sec. to set the channel as a quiet channel.
  - Push [Q] to turn the quiet function ON. ("T SQL" appears.)
- ③ Wait for a call.
  - When receiving a call, the transmitting station's ID code may appear. 3 rings may be heard. (See the section at right.)
- ④ Operate the transceiver normally. (Push [PTT] to transmit; release to receive.)

### DISPLAY EXAMPLES

Calling station's ID code (12345) appears.

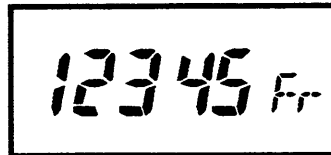

Appears when the transceiver cannot receive the 1st digit of the calling station's ID code.

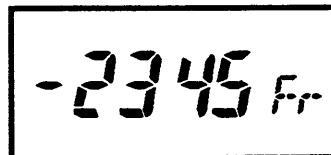

Appears when the transceiver receives its own ID code and the calling station's ID code is not included.

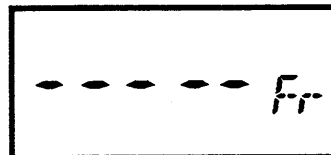

## ■ Calling bell on/off

SET mode

The transceiver emits 3 "rings" when receiving its own ID or group code. You can select silent standby by turning the calling bell OFF.

- ① If a channel number is not displayed, push or push and hold [A]•CLR in advance.
- ② Push [H/L•SET] for 2 sec. to enter set mode.
- ③ Push [#•▲] or [✕•▼] one or more times until "CB" (Calling Bell) appears as shown below.
- ④ Rotate the main dial to set the calling bell ON or OFF.
- ⑤ Push [A]•CLR to exit set mode.

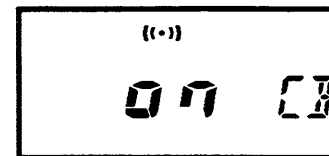

Calling bell is ON.

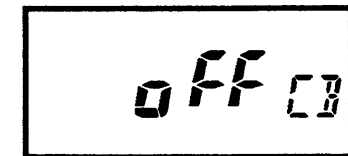

Calling bell is OFF.

### Confirming the ID code

You can confirm the ID code using a group call. Transmitting the group code (both the 4th and 5th digits are "A") displays your ID code on the other transceiver.

If your transceiver does not transmit its own ID code when calling, the ID code is not displayed.

## 4 5-TONE OPERATION

### ■ 5-tone code memory

The transceiver has 10 5-tone code memory channels.

#### ◇ Programming a 5-tone code

- ① Push [MONI] to enter 5-tone mode.
- ② Push 2 digit keys to enter the 4th and 5th digits.
  - "A" stands for a group code.
  - The main dial and [⊕•▲]/[⊗•▼] keys can also be used.
- ③ To program the displayed 5-tone code into a 5-tone code memory, push [MW] for 2 sec. then push the desired code channel number, [0]–[9].
  - All digits blink, then only the 4th digit blinks.

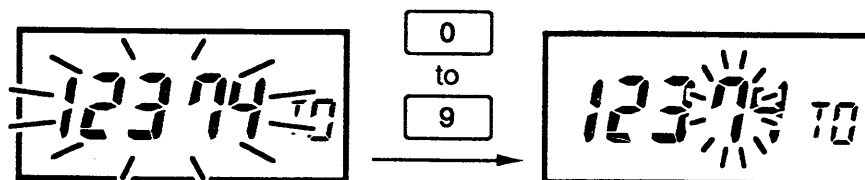

- ④ Push [Ⓐ•CLR] for 2 sec. to exit 5-tone mode.

#### ◇ Calling up a 5-tone code

- ① Push [MONI] for 2 sec. to enter 5-tone memory mode.
  - "-----" appears.
- ② Push the desired code channel number, [0]–[9].
  - The programmed code appears.
- ③ Push [Ⓐ•CLR] to exit 5-tone memory mode.

### ■ Quiet function

The quiet function provides communication with silent standby since you will not receive any calls until your ID code or group code is received. To activate the quiet function, quiet channel setting is necessary.

#### ◇ Quiet channel setting

- ① Select the desired channel.
- ② Push [Q] for 2 sec. to set the displayed channel as a quiet channel.

- This setting has no effect on the channel, however, the quiet function can be used only on channels set for the quiet function.

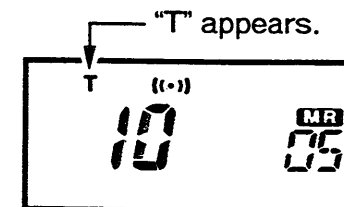

#### ◇ Turning the quiet function on/off

- ① Select the desired quiet channel.
- ② Push [Q] to turn the quiet function ON and OFF.

- "T SQL" appears.
- The quiet function activates on all quiet channels.

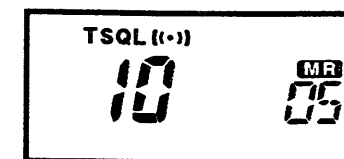

- While the quiet function is ON, the power saver duty cycle becomes 1:1 if the power saver is activated.
- Pushing [MONI] cancels the quiet function and selects 5-tone modes.

## Scan types

The transceiver has 2 scan types and 4 resume conditions to suit your needs. Scan channels are independently set for open and group scans. Initially, all channels are set as scan or non-scan channels for open or group scan, respectively.

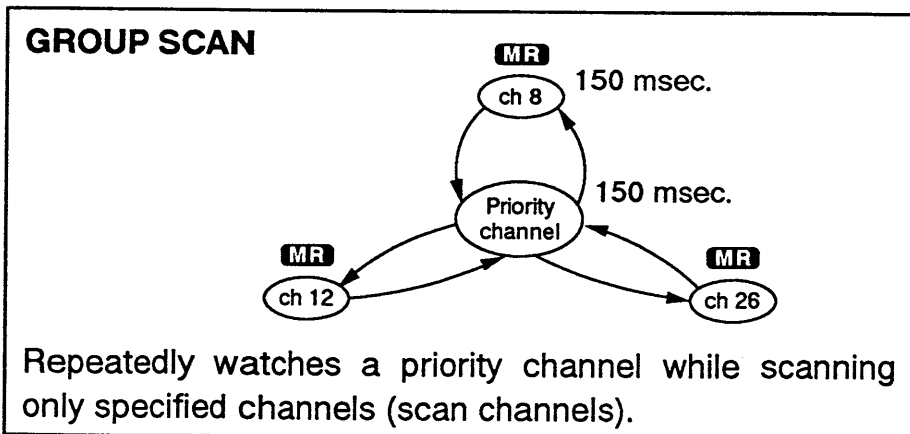
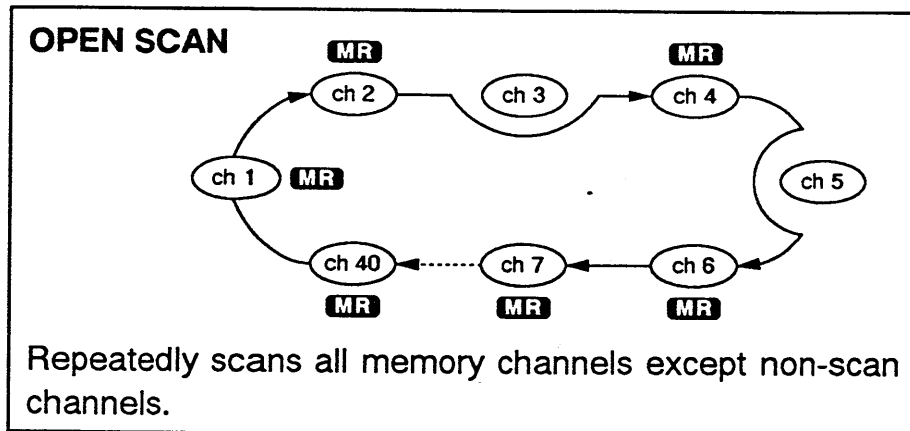

## Open scan

Open scan searches for transmitted signals automatically and makes it easier to locate new stations for contact or listening purposes.

- ① Push [OS/GS] to select open scan.
- ② Set [SQL] to the point where noise is muted.
- ③ Push [SCAN] to start open scan.
  - "SC" appears while scanning.
  - Cancelling scan channels speeds up the scan interval. (p. 18)

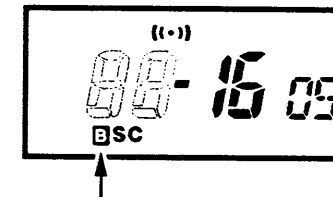

Appears when timer scan is selected for the scan resume condition. (p. 18)

- ④ When receiving a signal, scan pauses and resumes according to the selected scan resume condition. (p. 18)
- ⑤ Push [A]•CLR to stop the scan.

### Scan with the quiet function

When [Q] is pushed during scan, the quiet function is activated.

- "SQL" appears and quiet channels reject calls unless the correct 5-tone code is received.

## 5 SCAN OPERATION

### ■ Group scan

Group scan repeatedly watches a priority channel while scanning only specified channels. This is useful when waiting for calls on the priority channel or several specified channels.

- ① Push [OS/GS] to select group scan.
- ② Set 1 or more channels as scan channels for group scan in advance. (p. 18)
- ③ Set [SQL] to the point where noise is muted.
- ④ Rotate the main dial to select the desired priority channel.
- ⑤ Push [SCAN] to start group scan.
  - “SC” appears while scanning.

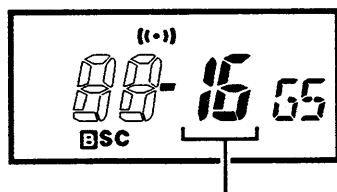

Shows the priority channel. The transceiver checks between the priority channel and group channels.

- ⑥ When receiving a signal on a priority channel, scan pauses and resumes according to the selected scan resume condition. (p. 18)
- ⑦ When receiving a signal on a scan channel, scan pauses on the channel until the signal disappears and checks the priority channel every 5 sec.

- ⑧ Rotating the main dial changes the priority channel during group scan.
- ⑨ Push [A]•CLR to stop the scan.
  - Pushing [PTT] also stops the scan and transmits on the priority channel.

#### Scan with the quiet function

When [Q] is pushed during scan, the quiet function is activated.

- “SQL” appears and quiet channels reject calls unless the correct 5-tone code is received.
- When receiving a signal, scan stops for 650 msec. on the quiet channel to check the 5-tone code.
- When the correct 5-tone code is received, 3 rings may be heard and the scan is stopped.

#### Standing by with the group scan and quiet functions:

- Transmit an appropriate 5-tone code several times (until an answer back call is received).
- Set only desired channels as scan channels.
- Select non-busy channel as the priority channel.
- Use the priority channel for calling, if possible.
- To transmit a 5-tone code, push [MONI]. Scan and the quiet function are automatically cancelled.

## Setting scan channels

Scan channels must be set before starting open or group scan. Scan channels are independently set for open and group scans.

- ① Select the desired channel.
- ② Push [OS/GS] to select the desired scan type.
- ③ Push [SCAN•MR] for 2 sec. to set the channel as a scan channel.
  - "MR" appears for scan channels.
- ④ Repeat step ③ to cancel the scan channel setting.

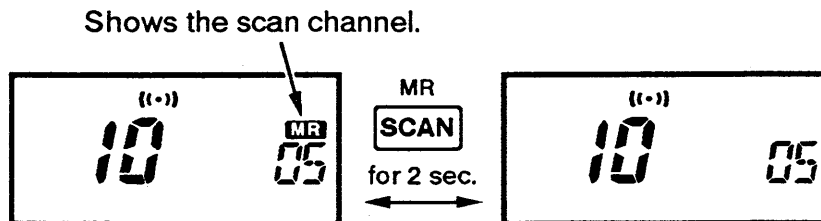

For open scan, cancel the scan channel setting to skip undesired channels such as usually busy channels. This speeds up the scan interval. All memory channels may be set as scan channels by default.

For group scan, set often-used channels as scan channels. No memory channels may be set as scan channels by default.

## Scan resume condition

SET mode

The scan resume condition can be selected as a pause or timer scan. "B" appears when 1 of 3 timer scans is selected while scanning. While the quiet function is in use, the scan resume condition is ignored on the quiet channel.

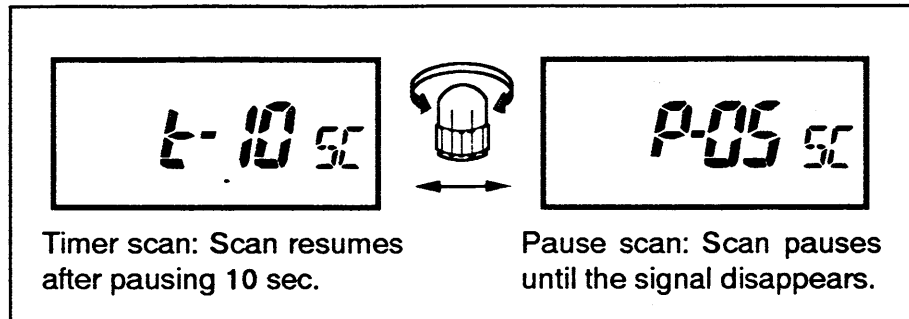

- ① If a channel number is not displayed, push or push and hold [A•CLR] in advance.
- ② Push [H/L•SET] for 2 sec. to enter set mode.
- ③ Push [#•▲] or [✳•▼] one or more times until "SC" (scan) appears as shown in the display.
- ④ Rotate the main dial to select the desired condition.
  - "t-15" : Scan pauses 15 sec. while receiving a signal.
  - "t-10" : Scan pauses 10 sec. while receiving a signal.
  - "t-05" : Scan pauses 5 sec. while receiving a signal.
  - "P-05" : Scan pauses until the signal disappears and then resumes 5 sec. after that.
- ⑤ Push [A•CLR] to exit set mode.

# 6

## OTHER FUNCTIONS

### Power saver

SET mode

This function reduces the current drain to conserve battery power while waiting on a channel. The power saver duty cycle has been set to 1:1, 1:4 or 1:16 by your dealer.

- ① Be sure a channel number is displayed.
- ② Push [H/L•SET] for 2 sec. to enter set mode.
- ③ Push [#•▲] or [⊗•▼] one or more times until "PS" (Power Saver) appears as shown at right.
- ④ Rotate the main dial to set the power saver ON or OFF.
- ⑤ Push [A•CLR] to exit set mode.



### Beep tone on/off

SET mode

The beep tone which sounds each time a switch is pushed can be turned ON or OFF, as desired. The calling bell for 5-tone calls can be turned ON or OFF separately. (p. 14)

- ① Be sure a channel number is displayed.
- ② Push [H/L•SET] for 2 sec. to enter set mode.
- ③ Push [#•▲] or [⊗•▼] one or more-times until "BE" (beep) appears as shown at right.
- ④ Rotate the main dial to set the beep tones ON or OFF.
- ⑤ Push [A•CLR] to exit set mode.



### Time-out timer

SET mode

To prevent continuous transmission, the transceiver has a time-out timer. This timer turns a transmission OFF 1, 2, 3 or 4 min. after it starts. This timer can be cancelled.

Approx. 5 sec. before the time-out time elapses, the transceiver emits a beep tone.

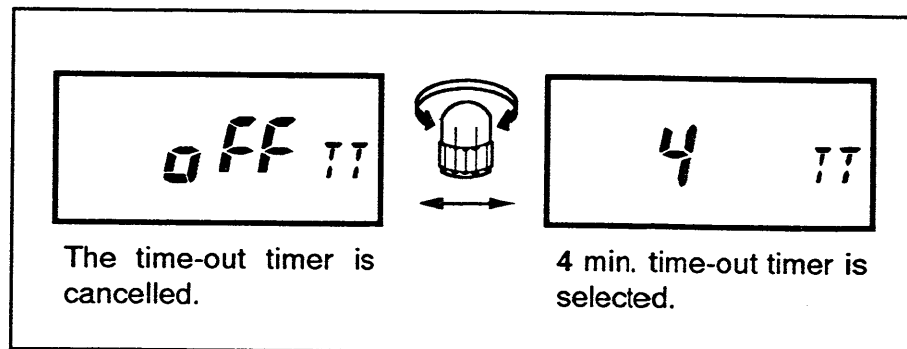

- ① If a channel number is not displayed, push or push and hold [A•CLR] in advance.
- ② Push [H/L•SET] for 2 sec. to enter set mode.
- ③ Push [#•▲] or [⊗•▼] one or more times until "TT" (Time-out Timer) appears as shown in the display.
- ④ Rotate the main dial to set the time-out time to 1, 2, 3, 4 min. or turn the timer OFF.
- ⑤ Push [A•CLR] to exit set mode.

# MODE ARRANGEMENT CHART

7

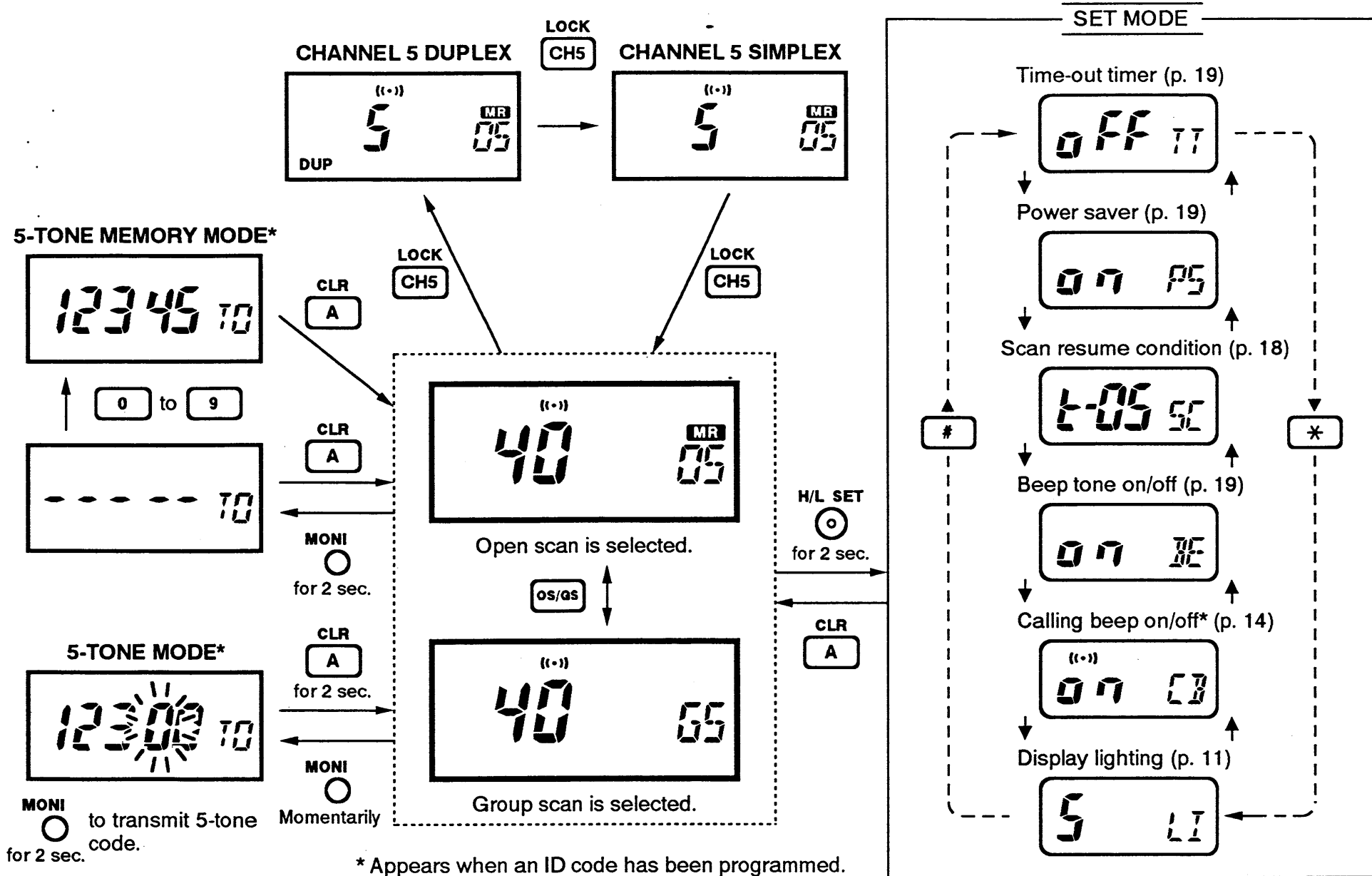

# 8

## TROUBLESHOOTING

PROBLEM	POSSIBLE CAUSE	SOLUTION	REF.
<ul style="list-style-type: none"> <li>No power comes on.</li> </ul>	<ul style="list-style-type: none"> <li>The battery is exhausted.</li> <li>Poor plug connection to the external DC power cable.</li> </ul>	<ul style="list-style-type: none"> <li>Charge the battery pack or place new dry cell batteries in the battery case.</li> <li>Check the connector or remove and replace the cable.</li> </ul>	pgs. 6, 7 –
<ul style="list-style-type: none"> <li>No sound comes from the speaker.</li> </ul>	<ul style="list-style-type: none"> <li>[SQL] is turned too far clockwise.</li> <li>An external speaker or earphone is connected.</li> <li>The quiet function is in use.</li> </ul>	<ul style="list-style-type: none"> <li>Rotate [SQL] counterclockwise.</li> <li>Unplug the speaker or earphone.</li> <li>Push [Q] to turn the quiet function OFF.</li> </ul>	p. 9 – p. 15
<ul style="list-style-type: none"> <li>Transmitting is impossible.</li> </ul>	<ul style="list-style-type: none"> <li>The quiet function is in use.</li> </ul>	<ul style="list-style-type: none"> <li>Push [Q] to turn the quiet function OFF.</li> </ul>	p. 15
<ul style="list-style-type: none"> <li>Channel cannot be set.</li> </ul>	<ul style="list-style-type: none"> <li>5-tone or 5-tone memory mode is selected.</li> <li>The lock function is activated.</li> </ul>	<ul style="list-style-type: none"> <li>Push [A]•CLR for 2 sec. to exit 5-tone modes.</li> <li>Push [F] + [CH5•LOCK] to deactivate the lock function.</li> </ul>	p. 15 p. 10
<ul style="list-style-type: none"> <li>Scan cannot be activated.</li> </ul>	<ul style="list-style-type: none"> <li>The squelch is open.</li> <li>The lock function is activated.</li> </ul>	<ul style="list-style-type: none"> <li>Rotate [SQL] clockwise until noise disappears.</li> <li>Push [F] + [CH5•LOCK] to deactivate the lock function.</li> </ul>	pgs. 16, 17 p. 10
<ul style="list-style-type: none"> <li>Repeater cannot be accessed</li> </ul>	<ul style="list-style-type: none"> <li>Channel 9–40 is selected.</li> <li>Duplex is not set.</li> </ul>	<ul style="list-style-type: none"> <li>Select channel 1–8.</li> <li>Push [DUP] to set duplex.</li> </ul>	p. 12 p. 12
<ul style="list-style-type: none"> <li>No contact possible with another station.</li> </ul>	<ul style="list-style-type: none"> <li>Duplex is set.</li> </ul>	<ul style="list-style-type: none"> <li>Set to simplex.</li> </ul>	p. 12

### ◇ Resetting

**CAUTION:** Resetting clears and initializes all programmed contents such as set mode, 5-tone memory contents, etc.

- While pushing [H/L] and [A]•CLR, turn power ON to reset the CPU.



## ■ GENERAL

- Frequency coverage : 40 of all UHF C.R.S. channels (476.425–477.400 MHz)
- Mode : FM
- Tuning step increment : 25 kHz
- Antenna impedance : 50 Ω (nominal)
- Power supply requirement: 6–16 V DC (negative ground)
- Current drain (at 13.5 V, typical):

Transmit	High power	1.8 A
	Low power	1.0 A
Receive	Rated audio	250 mA
	Power saved	35 mA (Average)

- Usable temperature range: – 10 °C to + 60 °C
- Frequency stability : ± 5 ppm (0 °C to + 50 °C)
- Dimensions : 57(W) × 125(H) × 35(D) mm (projections not included)
- Weight : 365 g (with BP-160 and antenna)

## ■ TRANSMITTER

- Selectable output power\* : High 5.0 W (at 13.5 V DC) Low 0.7 W
- Modulation system : Variable reactance frequency modulation
- Max. frequency deviation\* : ± 5.0 kHz

- Spurious emissions\* : Less than – 67 dB
- Microphone impedance : 1 kΩ

## ■ RECEIVER

- Receive system : Double-conversion superheterodyne
- Intermediate frequencies : 1st 35.8 MHz  
2nd 455 kHz
- Sensitivity\* : Less than 0.18 μV (for 12 dB SINAD)
- Squelch sensitivity : Less than 0.16 μV (at threshold)
- Selectivity : More than 15 kHz/– 6 dB  
Less than 30 kHz/– 60 dB
- Spurious response rejection ratio\* : More than 60 dB (More than 50 dB at IF/2)
- Audio output power\* : More than 0.3 W at 10% distortion with the 8 Ω internal speaker.
- Audio output impedance : 8 Ω

\* Specifications guaranteed at a transceiver temperature of + 25 °C.

**All stated specifications are subject to change without notice or obligation.**

# 10 OPTIONS

## ◇ Battery packs and chargers

BATTERY PACK	HEIGHT (with transceiver)	VOLTAGE	CAPACITY	CARRYING CASE
<b>BP-130A</b>	125 mm	Battery case R6 (AA) size × 6		LC-116
<b>BP-157A</b>	125 mm	7.2 V	900 mAh	LC-116
<b>BP-160</b>	125 mm	7.2 V	700 mAh	LC-116
<b>BP-174</b>	153.2 mm	12.0 V	600 mAh	LC-117

### CP-13/L

**CIGARETTE LIGHTER CABLE WITH NOISE FILTER**  
For operation and charging with a 12 V cigarette lighter socket.

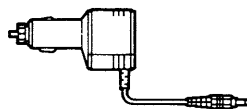

- CP-13: straight plug
- CP-13L: "L"-shaped plug

### OPC-288/L

**DC POWER CABLE**  
For operation and charging with an external DC power supply.

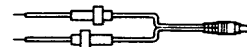

- OPC-288: straight plug
- OPC-288L: "L"-shaped plug

### BC-105V or BC-77V

**WALL CHARGER**  
Regularly charges a battery pack.

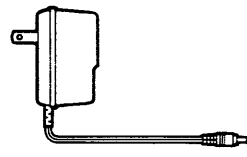

### AD-25 BATTERY CHARGE ADAPTER

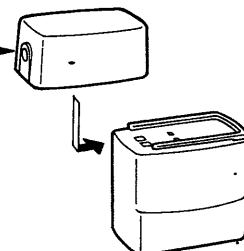

BP-157A, BP-160 or BP-174

- Approx. charging period
  - BP-130A, BP-157A, BP-160: 15 hrs.
  - BP-174: 20 hrs.

## BC-79 DESKTOP CHARGER + AD-28 BATTERY PACK ADAPTER

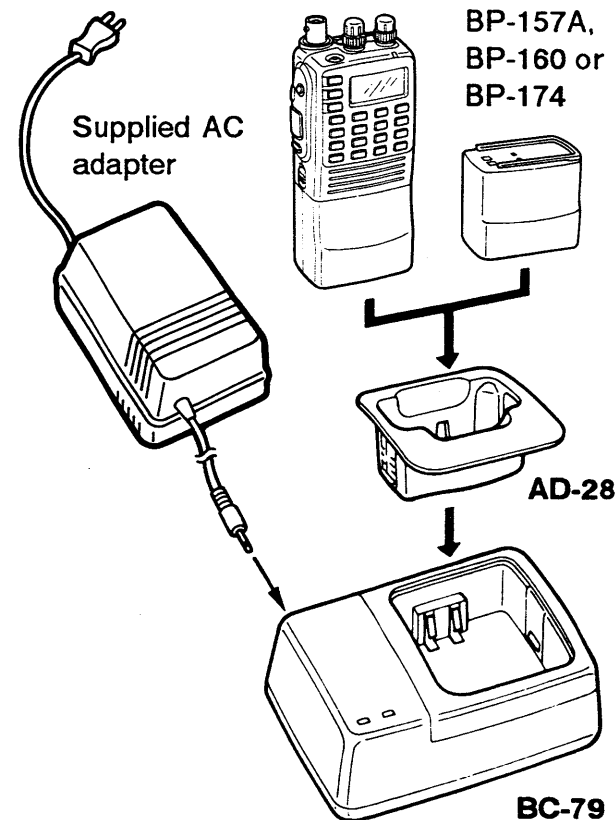

- Approx. charging period
  - BP-157A, BP-160: 1 hr.
  - BP-174: 1.5 hrs.
- An AC adapter is packed with the BC-79.
- The CP-13/L or OPC-288/L can be used instead of the supplied AC adapter.

◇ Speaker-microphones and headset

**HM-46/L**  
**SPEAKER-MICROPHONE**  
 Compact and lightweight.

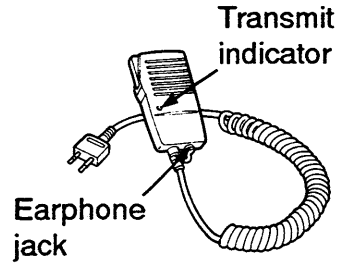

- HM-46 : straight plug
- HM-46L : "L"-shaped plug

**HM-55 DTMF**  
**SPEAKER-MICROPHONE**

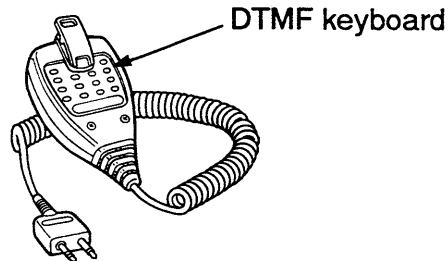

**HM-54**  
**SPEAKER-MICROPHONE**  
 Durable and full-sized.

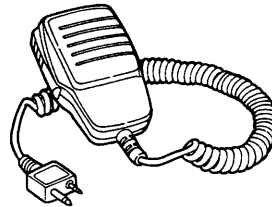

**HS-51 HEADSET**  
 Allows you hands-free operation.  
 Includes a VOX, PTT switch and  
 "one-touch" PTT (time-out-timer).

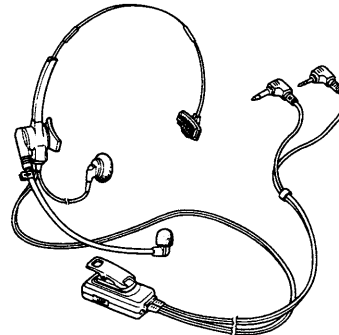

**MB-30 MOUNTING BRACKET**  
 Mounts the transceiver on a  
 vehicle or on a wall.

When using the  
 bracket hanger

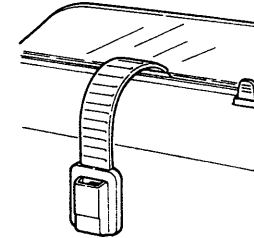

When using no  
 bracket hanger

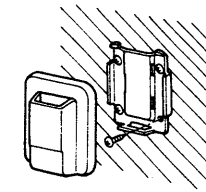

**FA-B72U FLEXIBLE ANTENNA**  
 The same type as supplied with the transceiver.

**SP-13 EARPHONE**  
 Provides clear receive audio in noisy environments.

**Count on us!**

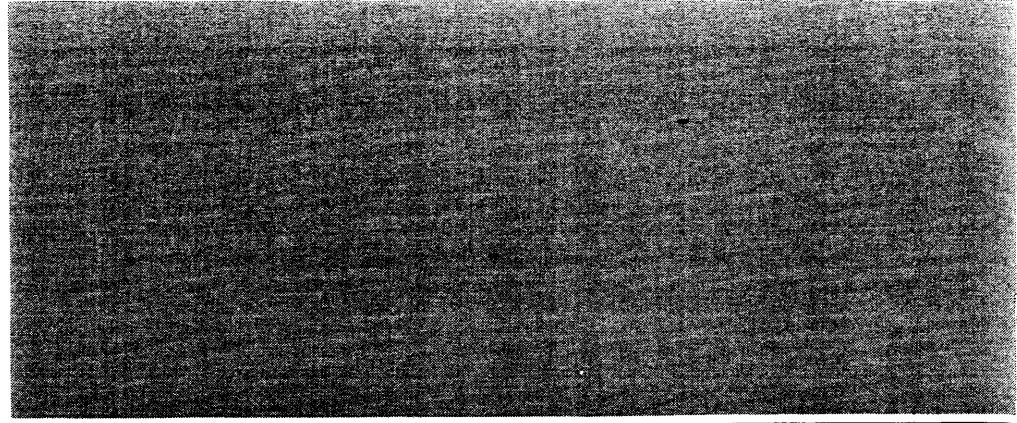

A-5308S-1AU  
Printed in Japan  
Copyright © 1994 by Icom Inc.

**Icom Inc.**  
6-9-16, Kamihigashi, Hirano-ku, Osaka 547, Japan

---